



AXALTA SUPPLIER DIRECTIVES EUROPE

Contents

AXALTA SUPPLIER DIRECTIVES EUROPE	1
Scope of this document:	3
1 Regulatory requirements	3
1.1 Code of conduct	3
1.2 Safety Data Sheets	3
1.3 REACh and CLP	3
1.4 Long term supplier declaration	4
2 Quality requirements	4
2.1 Adherence to specifications	4
2.2 Crater prevention	4
2.3 Quality management system	4
2.4 Management of change	5
2.5 Non-conforming deliveries	5
2.6 Complaint management (8D reports)	5
3 Delivery documents	5
3.1 Delivery notes	5
3.2 Certificate of Analysis	5
3.3 Cleaning certificates (bulk supply)	6
4 Requirements on packaging of raw materials	6
4.1 Bulk supply (liquids)	6
4.2 Drum supply	6
4.3 Pail Supply	6
4.4 Big bag supply	7
4.5 Bag supply	7
4.6 IBC supply	7
4.7 Pallets	7
4.8 Collection of returnable packaging (drums, pallets, IBCs, etc.)	8
5 Requirements on labels	8
6 Temperature sensitive materials	8
7 Deliveries and changes in delivery schedule	9
7.1 Delivery date and time	9
7.2 Change of delivery date and quantity versus PO	9

8	Requirements for trucks and truck-drivers.....	10
8.1	No combined transports with food or animal feed	10
8.2	Safe Loading	10
8.3	Language and general instructions.....	10
8.4	Personal Protective Equipment	10
9	Plant specific requirements	11
9.1	Wuppertal (Germany).....	11
9.2	Landshut / Essenbach (Germany)	11
9.3	Bulle (Switzerland)	11
9.4	Darlington (United Kingdom).....	11
9.5	Vaestervik (Sweden)	11
9.6	Guntramsdorf (Austria).....	11
9.7	Montbrison (France)	12
9.8	Huthwaite (UK).....	12
10	Appendices	13
10.1	Appendix 1: 8D Report.....	13
10.2	Appendix 2: Previous cargo restrictions (bulk deliveries).....	18
10.3	Appendix 3: Securing of Transport	20
10.4	Appendix 4: Time slot management Wuppertal and Guntramsdorf	27
10.5	Appendix 5: Big bag specifications (Wuppertal)	43
10.6	Appendix 6: Bag specifications (Wuppertal).....	46
10.7	Appendix 7: Wrap/Foil requirements (Guntramsdorf)	47
10.8	Appendix 8: Pallets requirements (Guntramsdorf).....	48
10.9	Appendix 9: Additional EX-Zone/Fire Protection requirements (Guntramsdorf).....	49
10.10	Appendix 10: Requirements for Tank deliveries (Guntramsdorf).....	50
10.11	Appendix 11: Requirements for Tank Deliveries (Wuppertal).....	51
10.12	Appendix 12: Requirements for packaging (Montbrison)	56
10.13	Appendix 13: Waiver for reconditioned drums	57
10.14	Static Dissipative Bags for powder sites	59

Scope of this document:

The directives listed in this document cover requirements to supply of materials to the following Axalta sites in Europe: Wuppertal, Guntramsdorf, Montbrison, Essenbach, Darlington, Vaestervik, Cerkezkoy, Bulle and Huthwaite. It is our intention to have - to the extent possible - same requirements at all sites. Nevertheless, logistic aspects cause some differences between sites.

This document will not focus on individual materials and their specifications. But some directives will apply only to specific material groups or a specific type of supply (like bulk supply in tank trucks).

1 Regulatory requirements

1.1 Code of conduct

Axalta expects all suppliers to comply to our *Code of Conduct for Suppliers* which can be downloaded on the Axalta web page:

https://www.axalta.com/corporate/en_US/about-axalta/values.html

https://www.axalta.com/corporate/en_US/sustainability/working-with-suppliers.html

1.2 Safety Data Sheets

To the extent required under REACH-Regulation (EC) Nr. 1907/2006 Seller shall provide (extended) Safety Data Sheet ((e)SDS) for Materials delivered under this Agreement. The (e)SDS shall be provided in the local language of the respective Axalta Coating Systems delivery point. Delivery of goods ordered shall only be complete once the respective accurate and up to date (e)SDS is provided. Seller is requested to send new or up-dated (e)SDSs to the mail-in-account provided for the respective Axalta Coating Systems shipping point.

Updated safety data sheets need to be sent to:

Wuppertal:	SDS-Mailbox-Wuppertal@axaltacs.com
Mechelen:	SDS-Mailbox-Mechelen@axaltacs.com
Landshut:	SDS-Mailbox-Landshut@axaltacs.com
Guntramsdorf:	sds-mailbox-guntramsdorf@axaltacs.com
Darlington:	sds-mailbox-darlington@axaltacs.com
Montbrison:	sds-mailbox-montbrison@axaltacs.com
Vaestervik:	sds-mailbox-vaestervik@axaltacs.com
Bulle:	sds-mailbox-bulle@axaltacs.com
Cerkezköy:	SDS-Mailbox-Cerkezkoy@axalta.com
Huthwaite:	sds-mailbox-Huthwaite@axalta.com

1.3 REACH and CLP

REACH: Regulation (EC) No 1907/2006 of the European Parliament and of the Council of 18 December 2006 concerning the Registration, Evaluation, Authorization and Restriction of Chemicals (REACH)

CLP: Regulation (EC) No 1272/2008 of the European Parliament and of the Council of 16 December 2008 on classification, labelling and packaging of substances and mixtures.

The supplier shall ship only substances or mixtures to Axalta Coating Systems that are compliant with the CLP and REACH regulation in its valid version.

Supplier shall not ship any chemical substance, materials or product not specifically included in the (e)SDS or any similar material document previously agreed between Axalta Coating Systems and Supplier, unless otherwise agreed to in writing by Axalta Coating Systems.

Supplier undertakes to inform Axalta Coating Systems in advance of any REACH restriction (including substances being subject to authorization: "SVHC" (Substances of Very High Concern) governing the use and disposal of substances supplied hereunder, including, but not limited to, any proposed or final amendment of the annexes to REACH concerning such restrictions.

Upon written request of Axalta Coating Systems, and subject to execution of a mutually acceptable confidentiality agreement if requested by Supplier, Supplier undertakes to promptly provide Axalta Coating Systems with all information or certifications as deemed reasonably necessary by Axalta Coating Systems to assess regulatory compliance and satisfy any applicable reporting requirements for the European Union.

1.4 Long term supplier declaration

Suppliers are obliged to provide on request supplier's declarations according to articles 61-66 of Commission Implementing Regulation (EU) 2015/2447 having regard to Regulation (EU) No 952/2013 of the European Parliament and of the Council.

Suppliers are responsible for correctness and completeness of such supplier's declarations.

The suppliers have to inform AXALTA in case of inaccurately issued supplier's declarations and shall bear full liability and responsibility for any claims resulting from such events.

2 Quality requirements

2.1 Adherence to specifications

All deliveries must comply with agreed specifications and must be substantially equivalent to the sample which was base of the approval as well as previous deliveries. The agreed specification can be a mutually signed Axalta specification or the last version of supplier's standard specification which was communicated to Axalta.

2.2 Crater prevention

Axalta Coating Systems is a manufacturer of coatings for the automotive and general industry. The performance of its products, in particular film building, and adhesion properties can be significantly influenced even by traces of surface-active materials such as silicone compounds, fluorinated materials, greases, oils, and surfactants ("contaminant").

The supplier ensures the awareness throughout his entire organization and is responsible to ensure that the material is free of substances causing wetting defects in coatings. The supplier must avoid known substances (e.g., silicones, halogenated substances, detergents) to get in contact with the raw material or its packaging throughout the entire process of manufacturing, handling and transport, including adequate information to involved third parties. Proof to this may be given in audits by Axalta Coating Systems.

2.3 Quality management system

We expect our suppliers to provide evidence that they have implemented a quality management system to DIN ISO 9001 or IATF 16949 and that they co-operate and work closely with us on safety and environmental protection, as set out in ISO 14001 and EU Regulation 761//2001 (Eco-Audit Regulation).

Please provide us with your valid confirmation of certification without request.

2.4 Management of change

Suppliers must inform Axalta Coating Systems of any change in manufacturing location and - process, processing materials, formulation, packaging material and auxiliary material. Axalta reserves the right to test a sample before such changes become effective.

2.5 Non-conforming deliveries

Should a supplier in exceptional cases not be able to supply Products that conform to the respective agreed specifications, supplier is obliged to inform AXALTA in writing about the detailed deviation and ask AXALTA for a deviation permit prior to delivery. A deviation permit is only valid for those properties, which have been the subject of supplier's written information.

AXALTA is not obliged to accept such Products with deviations from agreed specifications or to grant such a deviation permit.

2.6 Complaint management (8D reports)

In case we detect a defect of the material or service we will send out a complaint report which is based on the 8D form. Suppliers are requested to fill in the relevant information within the given timelines. The report must include a root-cause analysis as well as corrective and preventive actions to prevent further incidents (see Appendix 1).

3 Delivery documents

3.1 Delivery notes

All deliveries must be accompanied by delivery notes clearly stating:

- Address of Axalta destination
- AXALTA COATING SYSTEMS release/purchase order number.
- Name of the person who issued the order.
- Supplier product name.
- AXALTA COATING SYSTEMS product code (D-code and TIPS code, shown on order).*
- Net weight.
- Lot/batch number(s), (except for bulk).
- Net weight per lot/batch number if the delivery is from various lots/batches, when production lot is less than order quantity.
- Packaging type (cartons, drums, bags, IBC, big bags, can, pail).
- Number of units delivered.
- Identification (unique identifier) of trailer/container in combination with supplier product name (bulk)
- CMR Consignment Note or equivalent document.

*For Huthwaite only, the RM code is shown and not the TIPS code on the PO

3.2 Certificate of Analysis

With each delivery SUPPLIER shall send a quality certificate pursuant to DIN EN ISO 10204, 3.1 to AXALTA by e-mail / fax (see below), confirming that the delivered Products are in conformance with the specifications agreed upon. SUPPLIER shall transmit such certificate **PRIOR to delivery and preferred by mail.**

The CoA must list for all parameters the measured number as well as the tolerance range and the test method. Just a conformity statement is not enough.

CoA's need to be sent to the following Email addresses:

Wuppertal: axaltapruefzeugnis@axaltacs.com (non-Pigments)
coa-mailbox-wupp-208@axaltacs.com (Pigments)

Guntramsdorf: Vendor-COA@axaltacs.com

Landshut: CoA.landshut@axalta.com

Montbrison: emea-powder-supplier@axaltacs.com

Bulle: coa-mailbox-bulle@axalta.com

Vaestervik: emea-powder-supplier@axaltacs.com

Darlington: emea-powder-supplier@axaltacs.com

Cerkezkoj: emea-powder-supplier@axaltacs.com

Huthwaite: coa-mailbox-Huthwaite@axalta.com

3.3 Cleaning certificates (bulk supply)

Axalta requests cleaning certificates for tank trucks / -tainers (see section 4.1) with every delivery.

If dedicated trucks are used, please provide a certificate of conformity.

4 Requirements on packaging of raw materials

All changes regarding packaging materials need to be announced to Axalta up-front (regional procurement category manager).

Packaging must be in good condition. Damaged drums, bags, pallets, cartons etc. will not be accepted. Damage includes dents, rust, ripped bags, broken pallets etc.

Material destined for AXALTA COATING SYSTEMS sites must be loaded in such a way that this material can be unloaded without manipulation of other goods.

We can only expect drums, pails or bags from one lot per pallet. Deviations from this rule (for very small order sizes) need to be agreed to by the affected site(s).

4.1 Bulk supply (liquids)

Full truck load order size must be delivered only in one-compartment tank trucks. In special cases also multi compartment trucks are allowed. This must be communicated.

Delivery papers for all bulk deliveries must contain a cleaning certificate, showing the last loading of the tank and the tank identification. Axalta reserves the right to reject of bulk deliveries if the preloaded material is part of our list of potentially crater-causing substances (see Appendix 10.2). Revisions of this list can be requested from Axalta by email (bulk_deliveries@axaltacs.com).

See site specific requirements for connectors (Appendix 10.10 and 10.11).

4.2 Drum supply

Only **new** steel drums are accepted by Axalta coating Systems. In case supplier wants to use reconditioned drums or plastic drums, an official waver must be signed by the supplier. (See Appendix 10.12). Always please contact the responsible procurement category manager!

Drums must always be stacked on Pallets and must be fitted with Tri-sure caps.

When using clamping ring drums, the closures must be turned inwards.

4.3 Pail Supply

Pails should be of steel construction and groundable. The brut weight should not exceed 25kg.

4.4 Big bag supply

All FIBCs must be "Type C" (conductive, groundable bags) and shall be certified in accordance with the most recent edition of IEC 61340-4-4. If the FIBC contains a plastic liner, the liner shall be static dissipative in conformance with the most recent edition of IEC 61340-4-4.

Other FIBCs (Type D or B) require special agreement.

They must be connected with pallet as one unit (stretch wrapped or taped).

See Appendix 10.3.

Specific requirements on static dissipative for powder sites see Attachment 10.13

4.5 Bag supply

Paper bags are preferred but in case this is not possible, only static dissipative (antistatic) plastic bags are allowed and they can only be accepted in case this is agreed upfront. See MINIMUM specifications below:

- Static Dissipative (antistatic) plastic bags **must** meet either the NFPA35 or EN 60079-32 surface resistivity requirements:

- NFPA 35: A material having a surface resistivity less than 1.0×10^{11} ohms per square when tested at 23°C (73°F) and 20% relative humidity.
- EN 60079-32: A material having a surface resistivity between 1.0×10^5 and 1×10^{12} ohms per square when tested at 20-25°C and 25% relative humidity.
- Antistatic plastic bags must be properly labelled on the outside to avoid confusion.

A certificate needs to be sent upfront (before first delivery) to confirm that the plastic is anti-static and conform (or better than) our specifications. In case more info is needed, please contact your buyer.

For Wuppertal details: See Appendix 10.6.

Specific requirements on static dissipative for powder sites see Attachment 10.13

4.6 IBC supply

All containers should have a non-damaged 3" (DN80) outlet. Two sides should be usable for labelling.

Containers for combustible liquids must be of steel construction having a groundable outlet and breather (normal vent for filling and emptying) and emergency venting (pressure relief for fire exposure).

Exception is for non-combustible liquids or conductive combustible liquids that will not sustain combustion. On special agreement these liquids can be supplied in "groundable" plastic IBC's (wrapped by a metal grating with a mesh distance less than 10cm by 10cm or wrapped completely by a metal cover). They should have a device for grounding the interior of the container and approval to be used in an Ex Zone 1 (Class I, Division1) area.

4.7 Pallets

Please deliver on pallets which are in good condition and are suitable for a hand elevating truck and forklifts (e.g., CP 1 pallets). For drum deliveries we expect CP 3-pallets only.

Bags and Big Bags must not overhang pallets, drums and other ridged units may only overhang slightly (see pictures in attachment ...).

Material on pallets must be secured.

The drums on the pallets should only be secured with a plastic strap, not with a steel strap and not be covered with wrapping foil.

The maximum load capacity per pallet must be observed.

For Guntramsdorf details: See Appendix 10.8

4.8 Collection of returnable packaging (drums, pallets, IBCs, etc.)

Returnable packaging needs to be discussed with the receiving sites prior to first supply. Some sites may not accept at all.

Suppliers are to arrange collection pick-up at the Axalta site, within 24 hours after the request to collect is given.

If not collected, return can be arranged by AXALTA COATING SYSTEMS at the supplier's expense.

For the collection of material and returnable packaging, the driver must present clear instructions on the product and/or returnable packaging that is to be loaded.

5 Requirements on labels

In addition to the hazard label (when required), every recipient (bag, drum, carton, pail, IBC, can, etc.) must be properly labelled. The following minimum data must be shown:

- European Consumer label (EG directive 67/548/EEG of 27/06/67 concerning classification,
- Packaging and identification of hazardous products and EG directive 88/379/EEG of 7/06/88 concerning classification, packaging and identification of hazardous preparations).
- Supplier product name
- Lot/batch number
- Net and gross weight
- Axalta raw material codes (TIPS) if applicable.

Every handling unit (pallet, drum etc.) will have one label showing AXALTA COATING SYSTEMS' release/purchase order number.

Material sensitive to temperature deviation must be labelled as such e.g., *'keep from freezing'*.

Labels need to have a minimum size of 15 x 10 cm.

6 Temperature sensitive materials

Delivery temperature must be within the defined storage temperature range (which is defined in the specification or technical data sheet).

Supplier takes all risks of any deviation from the storage temperature range during transport (unless Axalta is responsible for the delivery process) and until delivery. If such deviation is acceptable in supplier's opinion, Axalta requests upfront information.

On request, driver needs to provide temperature protocol for thermal transports (starting from the loading and including full transportation period until delivery).

Wuppertal: For specific requests regarding temperature of bulk materials see Appendix 10.11.

7 Deliveries and changes in delivery schedule

7.1 Delivery date and time

Deliveries shall be made only on the day specified on the release/purchase order.

Some of Axalta's plants are located close to a residential area. Please respect the local traffic legislation (e.g., according to parking spaces and speed limitations).

Receiving hours are varying by plant. Delivery outside of these hours must be agreed upon beforehand with the contact person mentioned on the purchase order.

Wuppertal: Tankers: Monday-Friday: 07:00 am till 12:00 am,
Others: Monday-Friday: 07:00 am till 14:00 pm

Wuppertal is using a time-slot-management.

You need to register your delivery. Details see Appendix 10.4.

Guntramsdorf: Tankers: Monday-Thursday: 06:45 am till 11:30 am,
Friday: 06:45 am till 9:30 am

Others: Monday-Thursday: 06:45 am till 02:30 pm,
Friday: 06:45 am till 11:30 am

Guntramsdorf is using a time-slot-management.

You need to register your delivery. Details see Appendix 10.4.

Landshut: Monday to Friday 08:00 - 14:00

Montbrison: Monday to Friday 07:00 - 15:00

Bulle: Monday to Thursday 7:30 – 11h30 13:00 – 16:30
Friday 7:30 – 11h30 13:00 – 16:30

Darlington: Monday - Friday 08:00 – 15:00

Vaestervik: Monday to Friday 06:50 - 15:00

Huthwaite Monday to Thursday 7:30 – 12.30 13:15 – 15.00
Friday 7:30 – 11.30

7.2 Change of delivery date and quantity versus PO

Axalta accepts deliveries (packed materials only) on the requested day or up to two working days early. Delivered quantities must not be outside of a +/- 5% window. All deviations from these tolerances will be treated as a failure in our OTIF (On-time-In-Full) statistics which is a major factor in our supplier performance assessment.

If you cannot meet the requirements on the PO, please immediately contact the person shown on the purchase order.

8 Requirements for trucks and truck-drivers

8.1 No combined transports with food or animal feed

Advertising on the truck for food/animal feed could be an indicator for the additional supply of food. In this case, we will reserve the right to complaint this delivery.

8.2 Safe Loading

Trucks need to be loaded safely. Goods for Axalta need to be loaded in a way that they can be unloaded at our plant without moving other goods. For more details see Appendix 10.3.

8.3 Language and general instructions.

Drivers must have sufficient knowledge of local language or at least English.

Drivers **shall** report to the gate, read safety rules or watch safety video and sign-off for adherence.

Drivers **shall** follow instructions from plant personnel.

Truck driver must be present during loading and unloading activities and must be able to act according to instructions in case of emergency.

8.4 Personal Protective Equipment

Drivers are expected to present with the appropriate personal protective equipment:



Wuppertal: See also Appendix 10.9-11.

9 Plant specific requirements

9.1 Wuppertal (Germany)

See specific information in the attachments.

- Time slot management (Appendix 10.4)
- Bag specifications (Appendix 10.6)
- Big Bag specifications (Appendix 10.5)
- Requirements for Tank Deliveries (Appendix 10.11)
- Securing of Transport (Appendix 10.3)

Unloading of trucks from the side must be possible.

9.2 Landshut / Essenbach (Germany)

We are not able to unload the trucks with double stacked raw materials and we do not have an unloading ramp. We can therefore only unload trucks with **curtain sides**.

Due to limited unloading capacity, we need delivery on the requested date and all changes in delivery date need to be communicated with the contact person on the purchase order 24 h in advance.

Static Dissipative Bags for powder sites: Appendix 10.13

9.3 Bulle (Switzerland)

No loading / unloading dock available.

Delivery in curtain side trailer truck preferred

Static Dissipative Bags for powder sites: Appendix 10.13

9.4 Darlington (United Kingdom)

All deliveries must be pre-booked via one of the below communication options.

Email: WarehouseAAPQ@axaltacs.com

Tel: 0044 1325 355371

Please deliver on pallets which are in good condition and are suitable for a hand elevating truck and forklifts (e.g., CP 1 pallets). Only use one-trip drums for deliveries in drums.

Static Dissipative Bags for powder sites: Appendix 10.13

9.5 Vaestervik (Sweden)

We can only offload trucks with opening on the side and not double stacked – hence no sea-containers!

Static Dissipative Bags for powder sites: Appendix 10.13

9.6 Guntramsdorf (Austria)

See specific information in the appendices.

- Time slot management (Appendix 10.4)
- Requirements for Tank Deliveries (Appendix 10.10)
- Securing of Transport (Appendix 10.3)
- Wrap/Foil requirements (Appendix 10.7)
- Pallets Requirements (Appendix 10.8)
- Additional EX-Zone requirements (Appendix 10.9)

9.7 Montbrison (France)

For safety reason it's required to evaluate before introduction in the shopfloor, the packaging of the raw material. If the packaging doesn't meet the requirements, it should be possible to stop the introduction.

See specific requirements in the appendix 10.12.

9.8 Huthwaite (UK)

All deliveries must be pre-booked via one of the communication options below.

Tel: 0044 (0)1623 553043

07811 025649

No loading / unloading dock available.

Delivery in curtain side trailer truck preferred

For Huthwaite bulk supply (liquid) and in special cases also multi compartment trucks are allowed. This must be communicated.

10 Appendices

10.1 Appendix 1: 8D Report

Quick Guide 8D-Report via iPDF



Quick Guide 8D-Report via iPDF (English)

Functions

The new online 8D-report will be the central Instrument for processing of complaints of Axalta Coating Systems

8D Methodology

Using the 8D Methodology enables a systematic approach and consequent documentation of the single steps of coming to a solution. The approach is fact based and makes sure that product or service defects are traced back to their root causes and that these are permanently eliminated, instead of covering the symptoms. The problem solution process is a sequence of steps that have to run through, as soon as a problem is recognized. It helps finding a complete solution in time and to avoid defect repetitions.

Advantages

- **Quick processing:** By means of the standard format QDX in Form of an interactive iPDF uncomplicated and quick exchange of information between the parties is enabled.
- **Process reliability:** The only prerequisite for working on the iPDF is an Adobe Reader version 7.1 or higher (free download at (<http://get.adobe.com/.....>)) Not using Adobe Reader may result in processing defects.

Procedure for completing the interactive form:

- 1) **Receiving the complaint**
- 2) **Working on the 8D-report**
- 3) **Reporting back steps D1 – D3**
- 4) **Saving and returning the 8D-report**
- 5) **Attaching files (optional)**

1) Receiving the complaint



Lieferantennummer / vendor number 0815		Kontakt Ansprechpartner / Contact person of contact CONTACT NAME	
Lieferant / supplier LIEFERANT		Telefon / phone 012345 987654321	
E-Mail Adresse PDF Empfänger / e-mail address PDF receiver		E-Mail / e-mail	
Ereignisbezeichnung / complaint title COMPLAINT NAME		Beurteilungswert / complaint ID 0815	Beurteilungsdatum / complaint date 04.07.2012
Materialbezeichnung / defective product number MATERIALNR		Menge / Qty quantity 3 ST	Reaktion / response DS 06.08.2012
Teilbeschreibung / part description MATERIALTEXT		Reklamierermenge / complained quantity 2 ST	Reaktion / response DS 10.08.2012
Lieferantencharge / supplier batch ID BATCH ID		Reklamierermenge / claimed quantity 1 ST	Feld ID (Report) / der date ID report 12.08.2012
Duplikat / Duplicate description / Dupliert defect description THIS IS THE DEFECT DESCRIPTION			

- (1) Open the iPDF, that was electronically sent as complaint. It will be pointed out if there are attachments to the iPDF right at the beginning.
- (2) Attachments can be called up by clicking on the paper clip icon that is displayed on top or on the left side dependent on the Adobe Reader version.
- (3) The iPDF-8D-report contains basic information like product description and customer complaint in the header.

2) Processing the iPDF (8D-report)

In the following the report is divided into 8 steps or 8 dimensions respectively (8D) that have to be reported back according to the target date. In general all red-rimmed fields have to be filled by you mandatory.

Step D1: Define the team that is qualified to solve the problem. When filling in the team members it has to be started with the team leader. Any team member added can be chosen later.

D1 - Team / D1 - team						
ID / ID		Arbeits / title	Name / name	E-Mail / e-mail	Telefon / phone	Köchen / delete
1						

Den Teamführer bitte als Erstes benennen! / Please name teamleader first!

- (1) Add additional team members (maximal 5 persons) to the report using the button "hinzufügen/add"
- (2) Remove team members by using the button "löschen/delete" if it has not been referenced to them in a subsequent step of the 8D-report.

Step D2: Describe the defect of the complained product/service from your point of view (supplier/ recipient of complaint)

D2 - Fehlerbeschreibung / D2 - defect description	
Status / status	Statusinformation / status information
(1)	(2)
Fehlerbeschreibung aus Lieferantenicht / defect description from supplier's point of view	
(3)	

- (1) Choose your statement in the drop down menus (pls. see the options to the right)
- (2) Categorize your statement by the next drop-down menu (pls. see option to the right)
- (3) Describe the defect from your point of view in the text field

Step D3: define your containment measures for avoiding repeated defects quickest possible. Adding and deleting is possible here by using the buttons, too.

D3 - Sofortmaßnahmen / D3 - containment actions						
Hinzulagen / add						
ID / ID	Titel / title	Vorantwortlicher / responsible	Plandatum / due date	Fertigstellungsdatum / completion date	Wirksamkeitsgrad % / effect degree %	Knoten / status
9301	(1)	(2)	(3)	(4)	(5)	
Maßnahmenbeschreibung / action description						
(6)						

- (1) Insert the title of the measure that shall prevent repeated defects.
- (2) Choose a team member (team members were defined in step D1) that is responsible for this measure.
- (3) Define the due date.
- (4) Record the actual completion date.
- (5) Degree of efficiency estimation: To which extent does the measure solver the problem. Allowed values range from 0 to 100.
- (6) Fill in a precise description of the measure in free text form. (What are in detail the proceedings to finalize the measure?)

If a complaint is refused D3 has to be filled anyway. In that case it is recommended to fill in as measure "none" or "product will be sent back to AXALTA".

3) After the steps D1 to D3 have been completed please send the document within two work days back to Axalta Coating Systems. Please use the direct send button in the lower right corner of the document or send the document as attachment by e-mail. You can always carry on working in the document, even if there are updates coming from AXALTA, as long as the complaint number is identical.

Step D4: Here all root causes that lead to the defect have to be filled in. Here as well several causes can be added or deleted. If a failure cause is added or deleted automatically the according steps in D5 and D6 are added or deleted.

D4 - Fehlerursachen / D4 - root causes	
<input type="button" value="hinzufügen / add"/> <input type="button" value="löschen / delete"/>	
Kurzbeschreibung (7M) / short description (7M)	ID / ID
(1)	9401
Ursachenbeschreibung / cause description	
(2)	

- (1) Chose in the drop down menu who or what is responsible for the defective supply.
- (2) Fill in a detailed cause description

Step D5: Define possible corrective actions for each cause and describe the effectiveness. Use also here the buttons “add” and “delete”, analog to the previous steps.

D5 - Abstellmaßnahmen / D5 - corrective actions						
<input type="button" value="hinzufügen / add"/>						
ID / ID	Titel / title		Verantwortlicher / responsible	Plandatum / due date	Wirksamkeitsgrad % / effect. degree %	
9511	(1)					löschen / delete
Maßnahmenbeschreibung / action description						
(2)						
Wirksamkeitsüberprüfung / effectiveness verification						
(3)						

- (1) Denominate the corrective actions (e.g. “Automatic printing of delivery documents”), the fields responsible, due date, effectiveness have to be considered analogous to the functions described above.
- (2) Make a precise description of the corrective measure
- (3) Indicate which positive effects the action has for both sides.

Step D6: Here please fill in the realized corrective actions as well as the prove of their effectiveness. If needed please use the buttons add or “delete” as well.

D6 - Wirksamkeitsprüfung / D6 - effectiveness evaluation							
<input type="button" value="hinzufügen / add"/>							
ID / ID	Titel / title		Verantwortlicher / responsible	Plandatum / due date	Fertigstellungsdatum / completion date	Wirksamkeitsgrad % / effect. degree %	
9611	(1)		(1)	(1)		(3)	löschen / delete
Maßnahmenbeschreibung / action description							
(2)							

- (1) Define a concrete action including responsible and due date enabling a continuous follow up of effectiveness
- (2) Describe the action defined before in detail.
- (3) Indicate the percentaged degree of effectiveness for reducing the problem for the particular measure.

Step D7: Define actions to prevent from reoccurrence of the same or similar defects in the future by implementing changes in the control or management systems.

D7 - Präventivmaßnahmen / D7 - preventive actions					
hinzuügen / add					
ID / ID	Titel / title	Verantwortlicher / responsible	Fristdatum / due date	Fertigstellungsdatum / completion date	löschen / delete
9701	(1)	(1)	(1)		
Maßnahmenbeschreibung / action description					
(2)					

- (1) Choose in the drop down menu which kind of preventive measures are carried out. Define responsible and due date.
- (2) Describe in detail what the preventive measure is about.

The optimal kind of preventive measure is to introduce or review a process that is documented in a product/process history. That makes sure that similar defects will not occur again in new developments or redesigns of a product.

Step D8: Quote the closure date of the 8D report.

D8 - Abschluss / D8 - closure
Abschlussdatum / closure date
(1)

- (1) Quote the closure date only, the appreciation of the team success is not specifically inquired by AXALTA.

4) Storing and sending back the 8D report

The 8D reports can be stored locally with the filled in contents.

Sending back the report to AXALTA:

By clicking on the direct sending button which is in the lower right corner of the document. If using a recent Adobe Reader version (10.1.4) you will be asked if the iPDF shall be sent with the desktop e-mail application or as internet e-mail. After the choice was made the report is sent back to AXALTA as normal e-mail with a standardized text, in which the iPDF is forwarded as normal attachment.

The completed 8D-report shall be sent back within the deadlines defined in the header.

Attention: The text of the standardized and automatically generated e-mail will not be read by AXALTA. **Therefore please always use the iPDF form or attachments for messages. Please don't change the file name of the document!**

5) Attaching files (optional)

Enclose files (e.g. Photos...) in the iPDF

- Click on the staple (left side of iPDF)
- Click on Add -> chose attachment

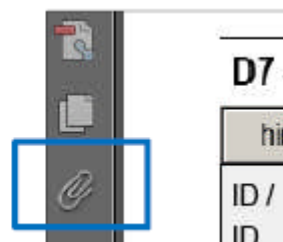

10.2 Appendix 2: Previous cargo restrictions (bulk deliveries)

Previous Cargo Restrictions for Bulk Truck Shipments / Solvents and Monomers

(Version 5.0)

- A **Cleaning Certificate** must be handed over by the driver before unloading at Axalta. The certificate must contain correct cleaning methods including bottom valve and closure of the tank, detailed description of the pre-loaded product.

For Europe EFTCO-conform certificate is mandatory.

If the certificate is missing, the driver must wait until the document is submitted. Axalta will not pay any demurrages. The certificate can also be sent to the following email address:

BulkDeliveries@axalta.com

- **Caustic clean, thorough rinsing and drying needed. Water insoluble compounds normally require chemical cleaning.**
- No reconditioned solvents for cleaning procedure
- Trucks have to be dry, clean and free of any odour (end control)
- Dedicated bulk trucks for a product or at least a family of products are preferred. No cleaning is necessary, if pre-loading is the same as the delivered material; please provide a certificate of conformity. Only complete removal of the pre-loading is requested.
- Last three deliveries must be silicone-free. If this is not possible due to truck shortage, Axalta needs to be informed upfront.
- Preloads are not permitted if they are labelled as proven carcinogenic, mutagenic and reproduction toxic (CMR):

Hazard classification	Hazard code and hazard warning (Regulation (EC) No 1272/2008)
Carcinogenic	Carc. 1A or 1B; H350 Carc. 1A or 1B; H350i
Mutagenic	Muta. 1A; H340 Muta. 1B; H340
Toxic to reproduction	Repr. 1A or 1B; H360F Repr. 1A or 1B; H360D

- The following product categories have been judged as non-washable, irrespective of the cleaning process, and are forbidden as pre-load:

Previous Cargo	Details
Adhesives	Solvent and water-based types
Amines	e.g., Pyridine and pyridine derivatives dodecylamines, aminoethylethanol amines

Previous Cargo	Details
Antistatic agents	e.g., quaternary ammonium salts, glycerol monostearate
Bitumen	or asphalt, tars
Colored Products	Dyes and optical brighteners, colorants, tinting pastes
Fluorocarbons or fluorine-based products	
Grease, Lube Oils, Engine Oils	e.g., Lubricants mineral oils containing additives, tall oil
Highly toxic Biocides	e.g., CMT (Chloromethylisothiazolinone), MIT (Methylisothiazolinone)
Latex, Dispersions and Emulsions	Latexes: Acrylic, vinyl acrylic and styrenic, styrene butadiene, etc.
Liquid Chalk and Slurries	Suspensions
Liquid Detergents, Fabric Softener	e.g., for washing machines
Mercaptans	e.g., Thiophenol, butanethiol
Molasses	
Paraffine, waxes with high melting point	except emulsions
Peroxides	Hydrogene peroxide, perhydrol dibenzoyl peroxide etc.
Pump and Hydraulic Oils, Brake Fluids	Could contain silicone!
Release agents / flow agents / mold and drawing oils	
Silicone compounds	Silicone, silicone oil, silicone waxes, siloxanes
Substances with intensive Odours	e.g., perfumes
Surfactants	Detergents, aromatic surfactants, synthetic surfactants, tall oil fatty acids
Used cooking oils and waste	Incl. waste oils

10.3 Appendix 3: Securing of Transport

Minimum Safety Requirements for raw material deliveries

1. Background

During the unloading of two Big Bags stacked upon each other from the warehouse shelves, the upper one sided from the one below and fell back into the rack. Fortunately, it did not fall from the third platform of the rack otherwise an employee could have been seriously injured.

2. Goal:

This specification shall avoid the replication of such an incident and ensures all employees physical integrity.

3. General instructions:

This requirement has to be handled like a specification for raw material.

Any loading unit has to be delivered in a safe way so that during the unloading, transport or storage there is no possibility of hazard for people, environment or technical equipment.

Any kind of loading unit has to be delivered on a stable wooden pallet which can be underrun by a manual forklift.

Single packages may not protrude over or slip from the pallet.

The covering material / wrap foil has to be conductive or antistatic.

Enclosed find some examples for a best possible loading unit, but also negative examples.

After the 1st of January 2011, goods receipt can be denied if the loading units will not be secured in a safe way.

4. effected packaging:

- 4.1 buckets / hobbocks
- 4.2 canister
- 4.3 barrels
- 4.4 bags
- 4.5 cartons / boxes
- 4.6 Big Bags

4.1 Buckets / Hobbocks

OK

NOK

Secured with security tape (vertical) and foil, wooden pallet can be underrun.



Drums unfixed on pallet.



Secured with security tape (horizontal) and foil, wooden pallet can be underrun.



Drums unfixed on pallet.

4.2 Canister

OK

NOK

Wrapped with foil, pallet can be underrun.
The foil must fix the pallet!



Canister unfixed on pallet.



Wrapped with foil, pallet can be underrun.
The foil must fix the pallet!!



Canister unfixed on pallet.



4.3 Barrels

OK

NOK

Secured with security tape (vertical and horizontal if more than 1 drum),
Pallet can be underrun.

unfixed



Wrapped with foil, pallet can be underrun.
The foil must fix the pallet!!

Pallet cannot be underrun.

4.4 Bags

OK

NOK

Wrapped with foil, pallet can be underrun.
The foil must fix the pallet!!

Security tape is too slack.



Wrapped with foil, first position covered with paper-board.
The foil must fix the pallet!!

Pallet cannot be underrun.

4.5 Cartons / Boxes

OK

NOK

Tightly wrapped with foil, connected with the pallet



Pallet cannot be underrun.



Cartons fixed with security tape. Additional security tape should fix the load with the pallet.



Cartons lying upon each other.



4.6 Big Bags

OK

NOK

Big Bag does not protrude over the pallet, secured with foil, connected with pallet.



2 Big Bags lying upon each other, tie-down completely missing.



Big Bag in Oktatainer, Oktatainer fixed with security tape and foil.



Pallet between Binbags, foil not strong enough, Big Bag on top can slip from the beneath one.



Axalta Training Document

TIME SLOT MANAGEMENT (TSM)

Content

10.2.1	Introduction	28
10.2.2	Overview Workflow	29
10.2.3	System Access	30
10.2.4	System Requirements	31
10.2.5	Role supplier (loading orders).....	31
10.2.6	Role freight forwarder (time slot booking).....	35
10.2.7	FAQs & Remarks.....	39

10.4.1 Introduction

We would like to inform you in this letter of a change in the goods receipt process at the **Wuppertal** and **Guntramsdorf** site of Axalta Coating Systems, which involves the introduction of **Timeslot Management System** for inbound deliveries. The change relates to deliveries of raw materials and packaging materials. At this moment, bulk tanker deliveries are not in scope.

Axalta Coating Systems strive to improve the efficiency of the inbound process. This will significantly reduce the processing time at the receiving points for you as suppliers, as well as streamline internal processes. To facilitate this project, the AEB Time Slot Management booking software was introduced.

For the following buildings / inbound ramps all deliveries must be registered on the time slot management portal <https://rz3.aeb.de/axaltaprod1ma>

Wuppertal:

- Building 270, gate 3, Hatzfelder Str. 200
- Building 247, gate 3, Hatzfelder Str. 200
- Building 221, gate 1, Märkische Str. 243

Guntramsdorf:

- ramp GU22/23
- ramp GU17
- ramp GU25

Please note, that in the case of a missing time slot booking or failure to comply with the booked time slot, timely discharging of goods may not be possible.

Existing contracts and delivery agreements, terms and conditions will remain unchanged. You will find the complete delivery address on the second page of our orders, including the corresponding building/ramp number, as well as a reference to the obligation to book a time slot.

By default, we provide you with one account with a password to access the booking tool. If required, you can set up additional accounts. The details of your account and time slot bookings are kept confidential and can only be viewed by you and certain Axalta users. Alternatively, if you choose to share your login details, you can instruct your logistics provider to handle the entire booking process for you.

To ensure a smooth process, we provide you with this training document describing the AEB tool and the process.

For additional questions, please contact:

Guntramsdorf: Tsm-support-guntramsdorf@axalta.com

Wuppertal: TSM-Support-221@axalta.com

Thank you very much for your cooperation!

10.4.2 Process Workflow

A sequence of defined roles is required for the timeslots in the Time Slot Management. The process chain starts with the creation of a loading order by the role supplier. The freight forwarder follows and can reserve a time slot with the supplier's loading order. This time slot will be confirmed and booked by Axalta. For a full overview, the role plant security and the role inbound for the internal processes are mentioned in the process flow diagram below.

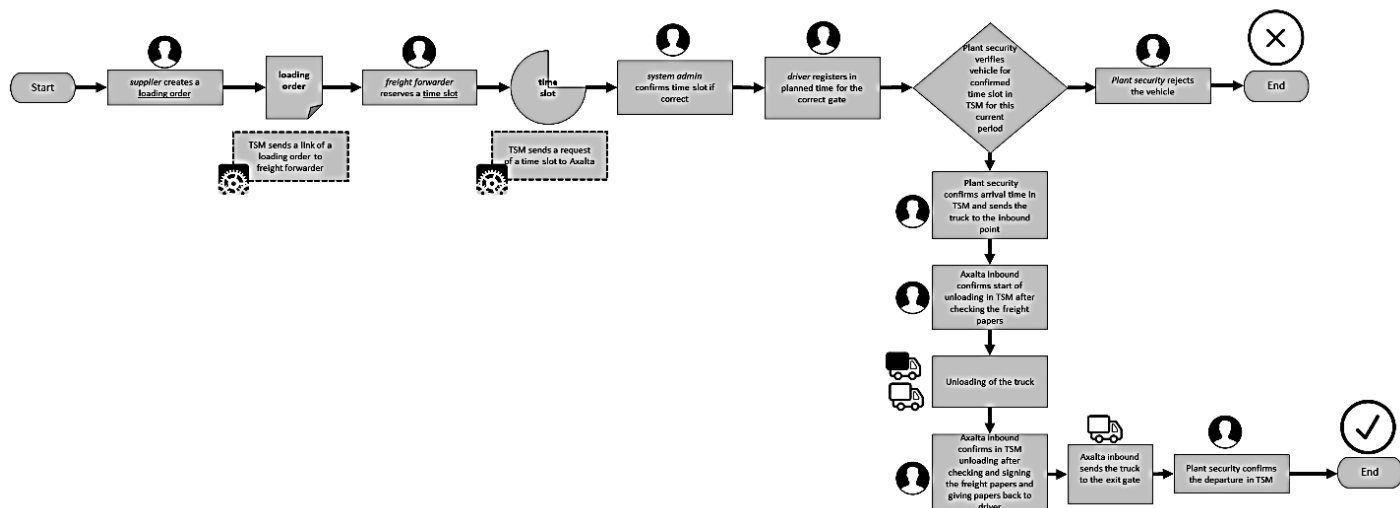

10.4.3 System Access

Please use the following link to log on <https://rz3.aeb.de/axaltaprod1ma>

Field Name	Input	Description
Client	AXALTA AXALTA_GU	Standard is Axalta. You deliver to the company Axalta Wuppertal AXALTA_GU. You deliver to the company Axalta Guntramsdorf
User	TSM_<Company Name>	Your username can be found in the separate info (client, user, one-time password, stored e-mail contact address).
Password	Axalta123	When you log in for the first time, you will be prompted to change the initial password once to a password you have chosen. The password is valid for 42 days or you manually change it via the user management password.
Language	German or English	The system can be used in German or English.
Forgot your password?	(Choose if required)	A password can be reset via "Forgot your password?" in the login window. A mail will be sent to the contact address you specified in the master data.

10.4.4 System Requirements

The time slot management software from AEB is a web application.

10.4.5 Role supplier (loading orders)

The process flow for booking a time slot always starts with the creation of a loading order by the supplier in the role supplier.

Three sub-items are available in the left-hand side of the “Time slot information” menu item. With the menu item “Loading orders”, the input / info mask for loading orders opens, where new loading orders can be created. The button „New“ leads to this input mask of a loading order.

In addition, the loading orders can be filtered and displayed in this screen depending on the status. The following filter options are most useful:

- Planned from
- Planned to
- Status
- Without time slot
- Without confirmation

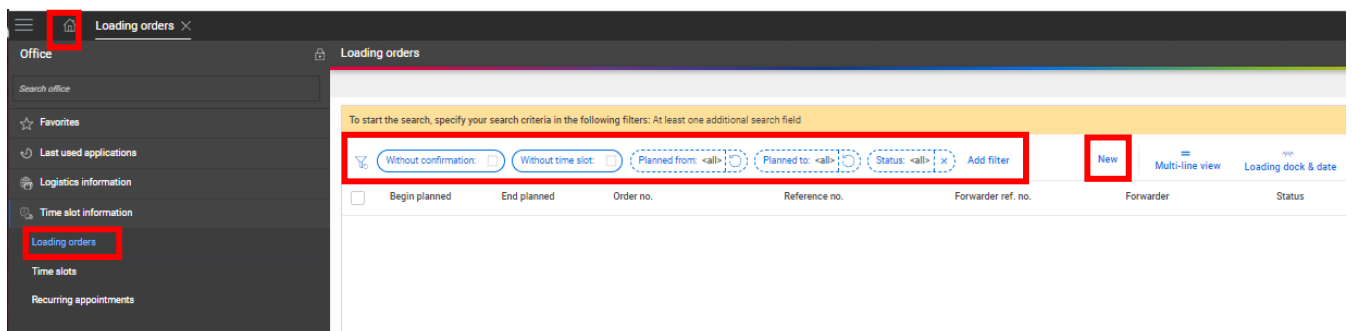

Alternatively, you can also use the button on the desktop  to create new loading order

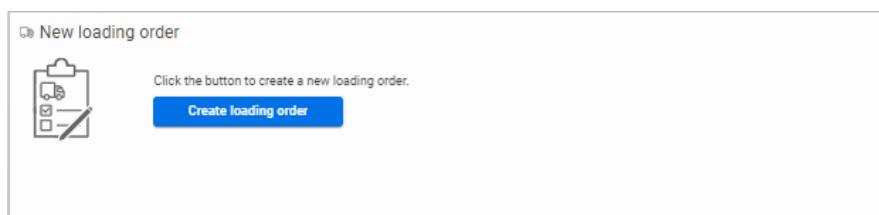

In the input mask for loading orders, the following information is mandatory, however, please pay attention to the instructions from the **TSM Assistant**, who will also guide you step by step through the time slot booking.

TSM Assistant
yellow info box gives hints to possible mandatory fields, etc.

Location: Select the inbound point (see Axalta purchase order page 2)

Reference No.: automatically generated number of the loading order; mandatory for booking and registration at plant security

Forwarder ref.: Axalta PO number (4XXX...). If more than 3, use "Remarks"

Remarks: Delivery date, other information

Loading type: It is already specified, otherwise, select „Unloading“

Transport type: Select „Truck“

Properties: select „Chemical raw materials“

Freight Forwarder: enter name, email, plate number of the freight forwarder and further fields if necessary

Loading order item: See below.

Loading order items” opens the below section in which the “Load device” is to be selected. Here you must choose “Pallet” as a load device from the list and enter the quantity of pallets and their weight.

Load Device: select PALLET, enter number of pallet and weight

Load device	Quantity	Weight	QU	Length	Width	Height	QU	Contents
<input type="text"/>	<input type="text"/>	<input type="text"/>	kg	<input type="text"/>	<input type="text"/>	<input type="text"/>	<input type="text"/>	<input type="text"/>

Important note:

As long as all the yellow mandatory fields are not filled, the blue hint text “Time slot not reserved” from the TSM assistant is not displayed and can not be selected.

As soon as all fields are filled in correctly, the button changes to status “Time slot not reserved”.

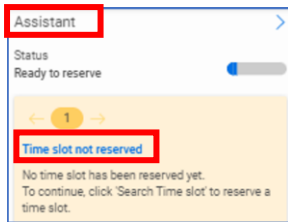

Notice: If the loading order does not have to be forwarded to the freight forwarder via email at this point (see below Role freight forwarder), this button “Time slot not reserved” takes you directly to the time slot search assistant.

A further hint that all mandatory fields have been entered in the “Loading order” tab is a newly added “Overview” tab. At this early stage, however, the overview contains not much of helpful details. This tab will be later on more important for tracking the loading orders.

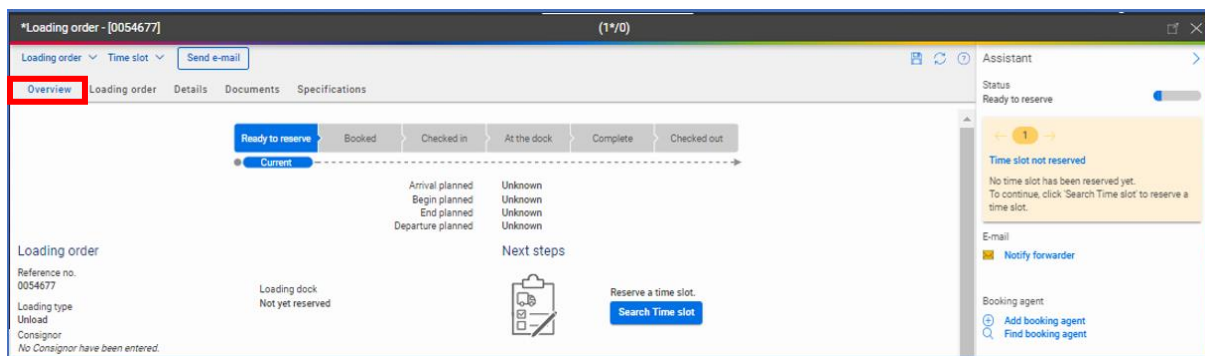

The “Details” tab is not relevant to create a loading order. If necessary, you can upload documents such as delivery notes, freight papers, analysis certificates etc. in the “Documents” tab.

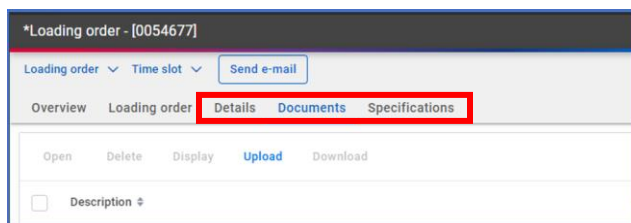

Besides the mandatory fields in the “Loading order” tab, further entries are required in the “Specifications” tab if the freight forwarder is to be given a time frame for booking the time slot. You have to enter two details in this case

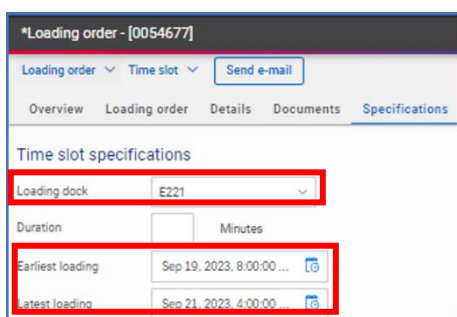

1. **Enter the loading dock:** The information details which loading dock to select you can take from the [Axalta order, page 2](#).

2. **Enter the un/-loading time period:** Please enter here the delivery date from the Axalta order including a 2-day lead-time according to the agreed delivery agreements. If the delivery date is e.g., 21.09.2023, you enter e.g., the time period from 19.09.2023 to 21.09.2023.

There are also two other points (3 & 4) to consider.

3. **Duration** should be left blank, because of automatic calculation of the time slot according to the number of Pallets. Axalta will correct wrong entries.

4. **Warehouse open hours:**

- Wuppertal: ramp 270 7 am to 3 pm.
- Wuppertal: ramp 221 8 am to 4 pm.
- Wuppertal: ramp 247 7 am to 3 pm.
- Guntramsdorf: Monday-Thursday 8:00 – 14:00h, Friday 8:00 – 11:30h

Only now all the necessary information has been stored and the loading order can be handed over to the forwarder with a click on “Notify forwarder” under the “E-mail” section on the right side of the screen.

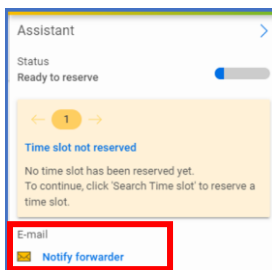

The transfer to the freight forwarder is done by a separate email. For this purpose, your mail program automatically opens with a stored link and is sent to the mail address previously stored in the loading order.

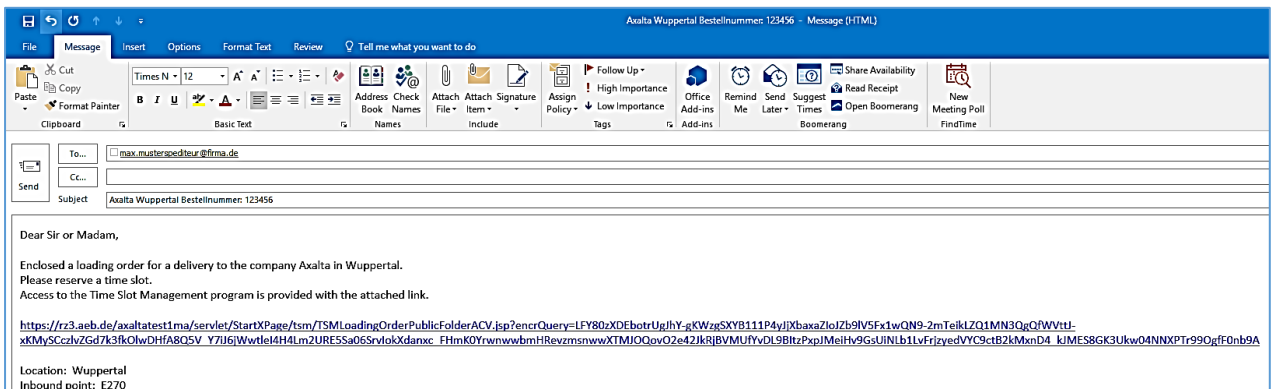

Alternatively, you can send the link to the forwarder directly from TSM.



For tracking purposes, you have the option to filter and display the status of the loading orders in this screen. The following filter options are most useful: Planned from, Planned to, Status, Without time slot and without confirmation. Also a complete omission of the to and from date is possible. In your example, you can omit "Planned from" and "Planned to" and select "Without time slot". All the loading orders that you have listed now appear, where the forwarder can select his individual time slot within your period and what has to be done by the forwarder.

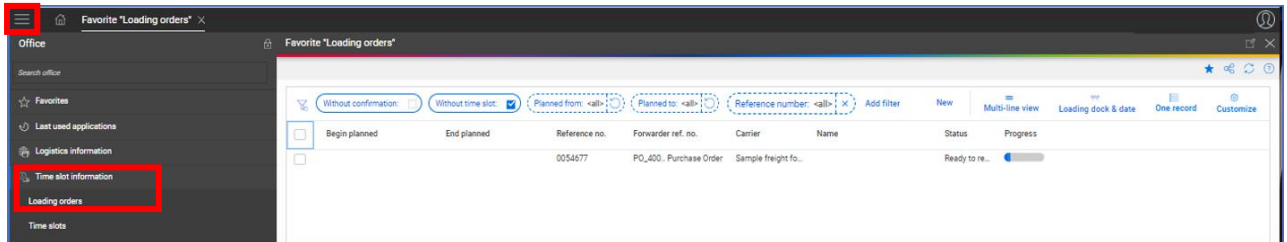

10.4.6 Role freight forwarder (time slot booking)

The next process step is the reservation of the time slot by the forwarder in the role forwarder according to your specifications and requirements as a supplier.

After the loading order has been created by the supplier, the freight forwarder stored in the respective loading order, gets a email with a link to the specific loading order in the role forwarder. When you open the specified link, your default web browser opens and the specific loading order from the supplier is displayed to the forwarder.

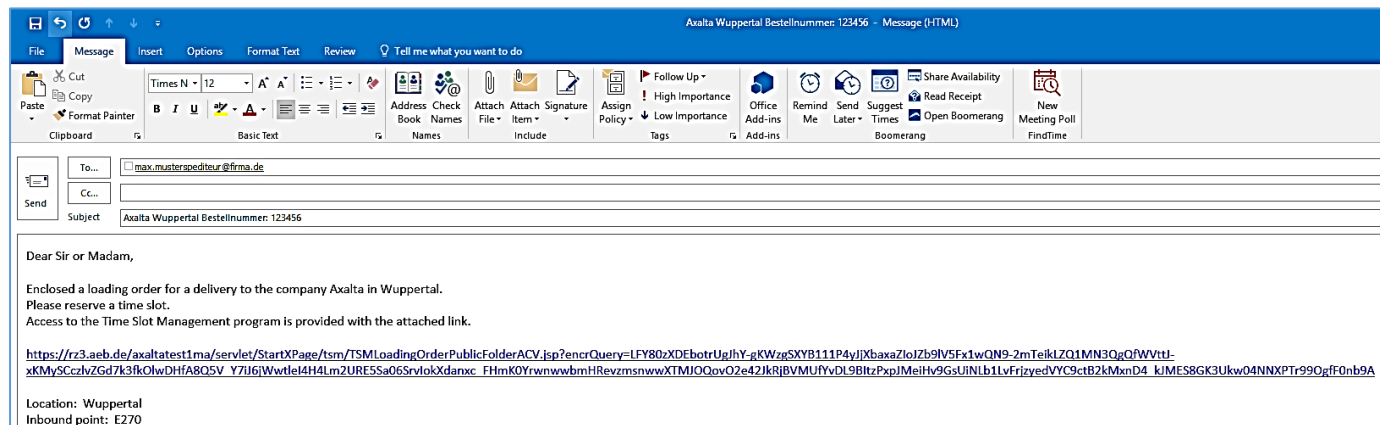

In order to work with the loading request, please click on "Activate change mode" in the yellow note area.

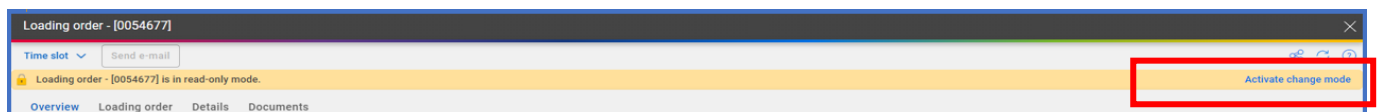

The main task of the forwarder is the search for a suitable time slot. For this purpose, usually has already provided the appropriate information in the system for the earliest and latest possible delivery (in the specifications tab).

The time slot search assistant opens via the "Search Time slot" button in the middle or at the top left of the loading order, and you can view the pre-sets and search for a suitable time slot within this given periods.

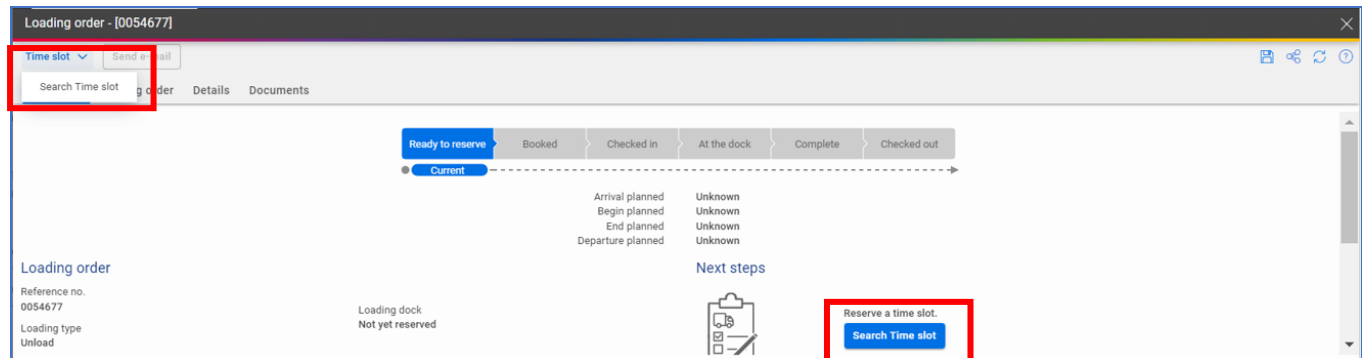

Clarification: The beginning of the time slot is meant to be the entry time to the plant. It is therefore **not allowed** to arrive / enter "at some point" within the time slot. Trucks are expected to arrive at least 15 minutes before the time slot starts for their registration.

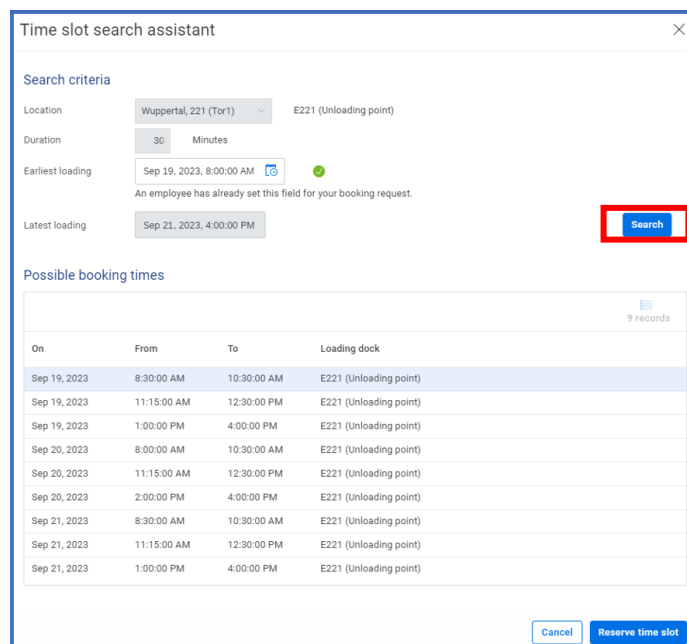

In the upper screen of the time slot search assistant, several possible booking periods are displayed. It is important to understand that these are system-related periods (depending on opening hours, break times etc.) and not the time slots itself. For this purpose, the first time period (here from **08:30-10:30 on 19.09**) is marked by the system as standard. It is also possible to select a different time period (for example, on **21.09** from **08:30 to 10:30**), in which the time slot can be reserved.

If the appropriate period has been selected above, the time slot can be defined more precisely. The system takes the first possible 30-minute time period (here: **08:30-09:00**) by default. This 30-minute section can also be from **10:00-10:30**.

You can enter the times directly in the earliest loading field and by the calendar widget (see below screenshot).

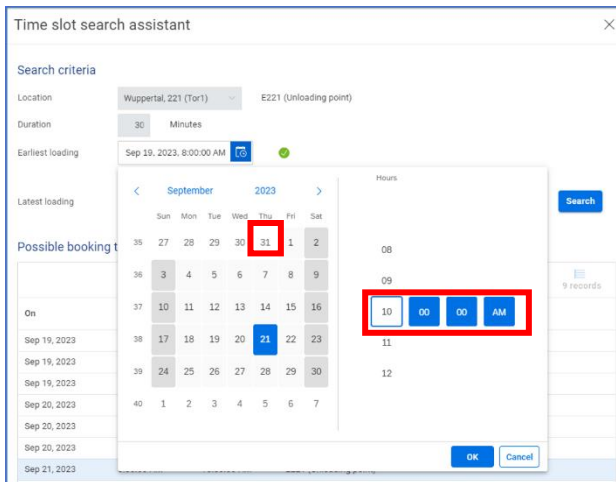

In the example below, the time slot 10:00-10:30 has been selected in the 08:30-10:30 period on 21.09.2023. In the "Confirm reservation" dialog box, the reservation request of this time slot is sent to Axalta for confirmation.

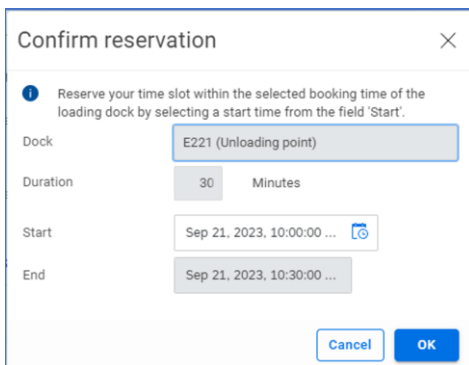

You can close the window by clicking on the blue "OK" button and an empty window with the logo of the system provider AEB appears.

Note: If the time slot is to be booked directly by the supplier without forwarding it to the freight forwarder, the "OK" button must also be clicked at this point.

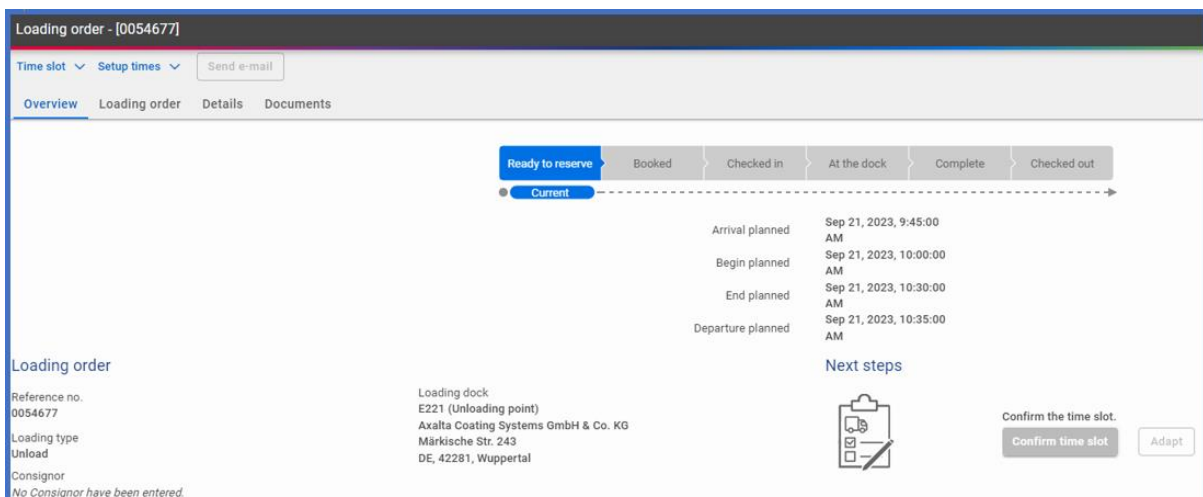

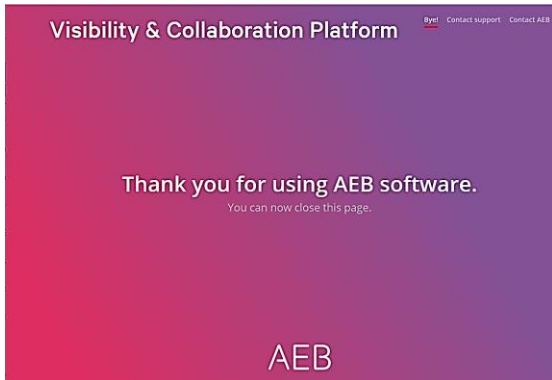

Note:

After a successful check or a possible adjustment, you will receive an automatically generated info email with a summary of all relevant details about the now bindingly booked time slot. This email is to be kept for any adjustments!!

Note: When arriving at plant security, the driver needs to present the

- Axalta-Purchase Order number and
- Loading Order number

Otherwise, the registration and tracking of inbound deliveries is not possible.

Important note on time slot adaptation and cancellation (see FAQs & Remarks below)

If the time slot does not fit later (due to a delay, etc.), adapt the time slot in the future using the link in your email booking confirmation as follows:

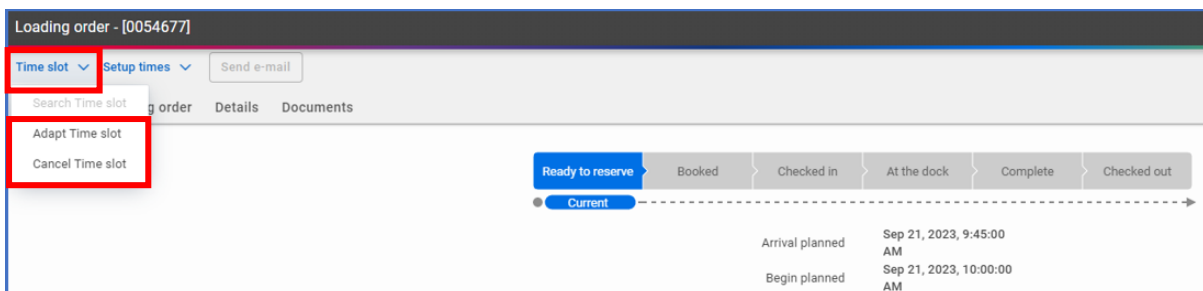

10.4.7 FAQs & Remarks

In the following chapter, you can find answers regarding frequently asked questions (FAQs) about the process flow and the involved roles. In addition, the correct handling of possible deviations is described.

1. In case of foreseeable delays and a passed time slot?

→ You have received a confirmation email from Axalta, if the reservation for the time slot is correct. This mail contains a link to the relevant loading order. After clicking the link, you have the possibility to adjust the time slot (see below), which in turn must be confirmed by Axalta again. This should only be done in exceptional cases in the context of efficient processing!

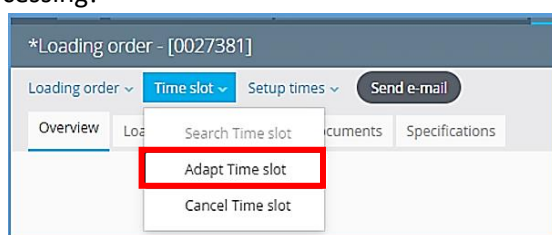

2. Which option is available if delays are foreseeable, and a time slot adjustment is not possible (due to no more available time slots)?

→ In these absolute exceptional cases an unloading is possible after a phone conversation with Axalta!

3. Multiple PO numbers within the same delivery?

→ If you have up to 3 PO numbers, please enter them in the "Forwarder Reference No." (input field).

→ If there are more than 3 PO numbers, please enter the other PO order numbers in the "Remarks" field.

4. Goods for both inbound points on the same truck?

→ Please reserve a time slot for the loading dock with the higher number of pallets. In the case of up to 5 pallets, the goods will be organized from one inbound point to the other internally by Axalta.

5. What is the procedure in TSM in case of a refusal of a delivery?

→ The booked loading order remains in the status "booked" and the system admin enters a note about the refusal in the "Remarks" field within the tab "Loading order".

6. Is it possible to define time slot series on a regular basis?

→ Series dates are possible after consultation with Axalta.

7. What must be done in TSM if the delivery date provided by Axalta can't be adhered to?

→ After consultation with Axalta and a confirmed new delivery date a new loading order can be created in TSM.

8. How long in advance can a time slot be booked?

→ A time slot can only be reserved if a loading order has been created by the supplier and according to the time requirements. To increase your planning security, it is advisable to create the loading order after receipt of the Axalta order.

9. Is it possible to exchange already booked time slots with other drivers (other supplier, other forwarder)?
→ This is possible after a phone conversation with Axalta and a remark in the remarks field in the loading order done by Axalta. This is possible if the time slots have the same length.
10. A time slot is booked for a truck for e.g., 8-9 am. Is a delivery possible at 8:40?
→ No, this is not possible! **An unloading** begins with the beginning of the time slot (here: 8:00) and the truck can enter the factory within 15 minutes before the start of the time slot (here: 7:45-8:00). The time between 8:00-9:00 includes the actual unloading and internal processing steps at the inbound point.
11. Is it possible to book several time slots with the same PO number?
→ When reserving the time slots, it is checked whether the PO number has already been used in the system for a different time slot. If this is the case, the reservation will not be confirmed and booked.
→ **Exception:** This is possible for an order with several items (with different delivery dates). In the "Forwarder Reference No." field, the PO number for the first item must be added with "Pos. 1", for position 2 with "Pos. 2" in a separate loading order, but with the same PO number, etc.
12. The loading order will be forwarded to a forwarder, who forward the order to a sub-forwarder. How is the loading order handled in this case?
→ For this purpose, the freight forwarder enters the sub-forwarder in the remarks field in the loading order tab (using the info email and the link stored there). In this way, the plant security and the inbound team will be informed about this change.

10.4.8 Additional Requirements for Guntramsdorf

English

G22

*** Important information for consideration***

It is imperative to deliver the material in Guntramsdorf in

building G22

As from 1st March 2021 please book with Time Slot Management:

<https://rz3.aeb.de/axaltaprod1ma>

If time slot booking is missing or is being ignored,

a timely discharge may not be possible.

G23

*** Important information for consideration***

It is imperative to deliver the material in Guntramsdorf in

building G23

As from 1st March 2021 please book with Time Slot Management:

<https://rz3.aeb.de/axaltaprod1ma>

If time slot booking is missing or is being ignored,

a timely discharge may not be possible.

G17

*** Important information for consideration***

It is imperative to deliver the material in Guntramsdorf in

building G17

As from 1st March 2021 please book with Time Slot Management:

<https://rz3.aeb.de/axaltaprod1ma>

If time slot booking is missing or is being ignored,

a timely discharge may not be possible.

German

Wichtige Information zur Beachtung*

Es ist zwingend notwendig, dass dieses Material in Guntramsdorf im

Gebäude G22 angeliefert wird.

Ab 01.03.2021 bitte über unser Time Slot Management avisieren:

<https://rz3.aeb.de/axaltaprod1ma>

Bei fehlender Zeitfensterbuchung oder Nichteinhaltung des

Zeitfensters ist eine zeitnahe Entladung u. U. nicht möglich.

Wichtige Information zur Beachtung*

Es ist zwingend notwendig, dass dieses Material in Guntramsdorf im

Gebäude G23 angeliefert wird.

Ab 01.03.2021 bitte über unser Time Slot Management avisieren:

<https://rz3.aeb.de/axaltaprod1ma>

Bei fehlender Zeitfensterbuchung oder Nichteinhaltung des

Zeitfensters ist eine zeitnahe Entladung u. U. nicht möglich.

Wichtige Information zur Beachtung*

Es ist zwingend notwendig, dass dieses Material in Guntramsdorf im

Gebäude G17 angeliefert wird.

Ab 01.03.2021 bitte über unser Time Slot Management avisieren:

<https://rz3.aeb.de/axaltaprod1ma>

Bei fehlender Zeitfensterbuchung oder Nichteinhaltung des Zeitfensters ist eine zeitnahe Entladung u. U. nicht möglich.

G25

*** Important information for consideration***

It is imperative to deliver the material in Guntramsdorf in

building G25

As from 1st March 2021 please book with Time Slot Management:

<https://rz3.aeb.de/axaltaprod1ma>

If time slot booking is missing or is being ignored,

a timely discharge may not be possible.

****Wichtige Information zur Beachtung*****

Es ist zwingend notwendig, dass dieses Material in Guntramsdorf im

Gebäude G25 angeliefert wird.

Ab 01.03.2021 bitte über unser Time Slot Management avisieren:

<https://rz3.aeb.de/axaltaprod1ma>

Bei fehlender Zeitfensterbuchung oder Nichteinhaltung des

Zeitfensters ist eine zeitnahe Entladung u. U. nicht möglich.

10.5 Appendix 5: Big bag specifications (Wuppertal)

Specification Big Bags for deliveries of solid materials Axalta Wuppertal

For all deliveries of solid materials, we require a Big Bag according to the following descriptions: Type C FIBC:

surface specification:

Bag made of woven synthetic fibre containing a matrix of conductive fibres that are interconnected to form a conductive path to a common, clearly identified grounding tab (see pic 1). Resistance to the grounding tab must be $< 10^8$ ohms from any point on the surface of bag. (According to 1/200-2.8 / BG Chemie)

The bag must be clearly identified as „Type C“, which indicates that it is suitable for use in the presence of combustible dusts and / or flammable vapours (see pic 2). Bag has to be equipped with four loops, construction of bag either tubular or four panel (preferred).

Pic1:



Pic2:

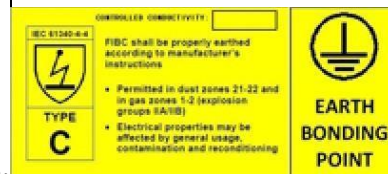

Dimensions:

- | | |
|----------------------------|--------------|
| a. Height: | max. 1000 mm |
| b. Length: | max. 1000 mm |
| c. Width: | max. 1000 mm |
| d. Length of strap: | 250 – 400 mm |
| Width of strap: | 40 - 60 mm |
| e. Length total: | max. 1550 mm |
| f. Diameter: | 390 mm |
| g. Length discharge: | max. 850 mm |
| h. Length to 2. Lacing: | 200 mm |
| i. Length after 2. Lacing: | 600 mm |

version A:

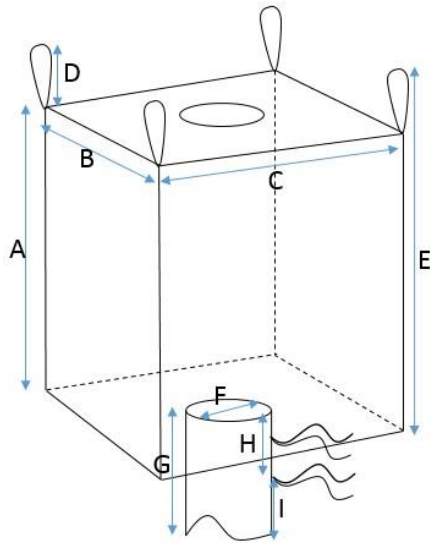

version B:

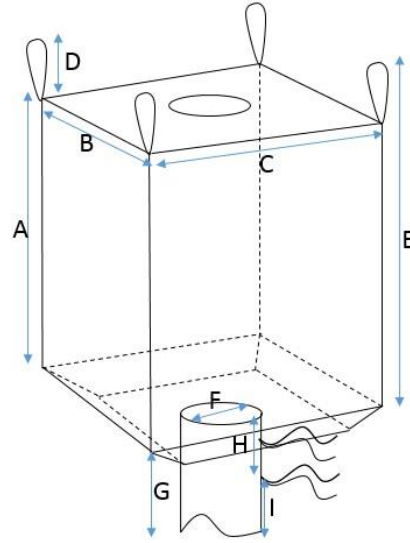

Safety factor : 6

Allowed capacity for pigments / filler: 200 or 400 or 500 or 1000 Kg
Allowed capacity for other raw: 500 or 1000 Kg

Material specification:

- polypropylene, UV-stabilized, DIN EN 1898 Quick UV-Test 200 H with min. break resistance 50%
- PP-cover
- electrostatic permanently dissipative
- strap material polypropylene
- in case of Big bags with in-liner, antistatic PE foil needs to be completely fixed, for filling and discharge spout, antistatic PE foil sewed.

Construction:

basic shape: four panel

Seams: sewed and sealed

Lifting:

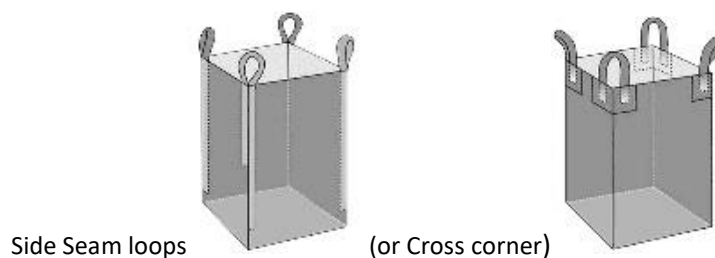

Filling & closure:



Filling spout

Discharge spout:

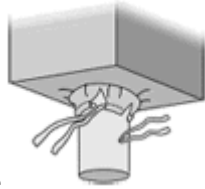

with petal closure

Identification:

Label: **pictogram of handling, Labelling Type „C“ (see pic 2)**

Pouch for documents: DIN A4

Delivery:

The delivery must be affected at once on CP3 or CP1 pallet and they must be connected with pallet as one unit (stretch wrapped or taped). Expedient a barrier between pallet and Big Bag.

10.6 Appendix 6: Bag specifications (Wuppertal)

Specification bags for deliveries of solid materials Axalta Wuppertal

Bags must either be of paper or "static dissipative" plastics (meeting the above specification for "static dissipative").

Plastic bags in cartons must be labelled "static dissipative" outside of the carton.

In case bags consist of 2 layers the inlay must be fixed to the outside layer of the bag. The maximum weight should not exceed 25kg.

Requirements to the surface at plastic bags:

Plastic bags must be antistatic or dissipative.

The packaging must have experienced a long-lasting antistatic or dissipative treatment. Antistatic surface resistance = less than 10^{10} ohms per square at 20-25 ° C and 50% relative humidity or less than 10^{12} ohm per square at 20-25 ° C and 30% relative humidity.

Labelling of plastic bags:

Label: **dissipative / antistatic**



Dimensions:

1.)

Approx. width: ca. 400 mm
Length approx.: ca. 600 mm
Height: ca. 100 mm

Maximum capacity: max 25 kg

OR

2.)

Width approx.: ca. 600 mm
Length approx.: ca. 1200 mm
Height: ca. 200 mm

Maximum capacity: max: 10 kg

Delivery:

The delivery must be affected at once on CP3 or CP1 pallet and they must be connected with pallet as one unit (stretch wrapped or taped). Expedient a barrier between pallet and bags.

10.7 Appendix 7: Wrap/Foil requirements (Guntramsdorf)

- Conductive or static dissipative (antistatic) according TRGS 727
- Certificate mandatory

Engl. Begriff	Conductive	Static dissipative
Resistance	TRGS 727: $\leq 10^4 \Omega$	TRGS 727: Between $10^4 \Omega$ and $10^9 \Omega$ (23 °C and 50 % relative humidity) Between $10^4 \Omega$ and $10^{11} \Omega$ (23 °C and 30 % relative humidity)
Resistivity	TRGS: $\rho \leq 10^4 \Omega\text{m}$ FP Standard: $< 10^6 \Omega/\text{sq}$	NFPA 35: $< 10^{11} \Omega$ (23° C (73° F) and 20% relative humidity) EN 60079-32: $> 10^5$ and $< 10^{12} \Omega$ (20-25° C and 25% relative humidity) IEC-60079-32-1: $< 10^{10}$ ohms per square when tested at 20-25°C and 50% relative humidity. $< 10^{12}$ ohms per square when tested at 20-25°C and 30% relative humidity

10.8 Appendix 8: Pallet's requirements (Guntramsdorf)

- No plastic pallets allowed.
- No CP9 pallets

10.9 Appendix 9: Additional EX-Zone/Fire Protection requirements (Guntramsdorf)

In general, no plastic packages are accepted. Exception only for

- IBCs: Either Ecobulk MX-EX ANTISTATIC or Ecobulk MX-EX conductive
- IBCs: Suitable for utilisation on explosion hazardous/ endangered premises classified as zone 1 and zone 2.
- Electrostatically safe in accordance with IEC/TS 60079-32-1:2013 and TRGS 727:2016
- Datasheet for IBCs and packages (drums, etc.) are mandatory.
- Plastic IBC's and packages only for water miscible, not combustion sustaining liquids with a flash point >35°C.

10.10 Appendix 10: Requirements for Tank deliveries (Guntramsdorf)

Samples must be taken by tank truck driver.

Required Personal Protective Equipment:

- Antistatic Safety Shoes.
- Antistatic non-flammable long clothing
- Safety glasses and face shield
- Chemical gloves
- Harness
- Language: Preferred German, Minimum: English
- Special requirements for the delivery of phenolic-cresol liquids.

Timeslots for delivery

- Monday to Thursday
 - 06:15
 - 09:00
 - 11:00
- Fridays
 - 06:15
 - 09:00

Other requirements and explanations for unloading road tankers.

- Working at height is only permitted by means of a 5-point harness.
- Rails are available to safeguard work at height.
- Unloading by pumping.
- Upfront COA (Certificate of analysis)
- Delivery papers for all bulk deliveries must contain a cleaning certificate, showing the last loading of the tank and the tank identification.
- Grounding connection
- Unloading connection: „ELAFLEX” coupling 3“
- Vapor return connection: „ELAFLEX” coupling 2“

Special cases:

- **PHENOL-CRESOL-MIXTURE: Unloading temperature in Guntramsdorf: 40°C-60°C**

10.11 Appendix 11: Requirements for Tank Deliveries (Wuppertal)

Tank Farm (Bulk Materials)

General re-quirements for all trucks	<ul style="list-style-type: none"> - Deliveries: 7:00 am - 12:00 am - If possible, only one chamber per product - For trucks: Handrail and continuously walkable area to all connections / hatches - Grounding Connection - Unloading connection: „German“ TW coupling 3“ right side or back side - Vapor return connection: „German“ TW coupling 2“(if necessary, an adapter should be on the truck) - Upfront COA (Certificate of analysis) - Delivery papers for all bulk deliveries must contain a cleaning certificate, showing the last loading of the tank and the tank identification.
---	--

Acrylic monomers, Styrene, Cresolic acid

	Special cases			
	Acrylic Acid	HEA	Cresolic acid	
General requirements for all trucks	<ul style="list-style-type: none"> - Delivery: 7:00 am - 12:00 am - If possible, only one product per chamber - For trucks: Handrail and continuously walkable area to all connections / hatches - Grounding connection - Unloading connection: „German“ TW coupling 3“ right side or back side - Vapor return connection: „German“ TW coupling 2“ 			
Additional personal protection	./.	Protective suit and full face mask	Protective suit and full face mask	Protective suit and full face mask
Delivery temperature	max. 32°C	max. 25°C min. 13 °C	max. 32°C	max. 60°C
Sample with delivery / Sample send upfront + COA (Certificate of analysis)	./.	./.	./.	Yes

Molten Monomers

General requirements for all trucks	<ul style="list-style-type: none"> - Deliveries: 7:00 am - 12:00 am - One chamber with unloading connection at the back or on the right/left side at the end of the truck. - For trucks: Handrail and continuously walkable area to all connections / hatches - Grounding Connection - Delivery temperature 10°C – 20°C above melting point - Unloading connection: „German“ TW coupling 3“ right side or back side - Vapor return connection: „German“ TW coupling 2“ - If a vapor return line is necessary, no flame arrester shall be installed! - Sample with delivery / Sample send upfront + COA (Certificate of analysis) 					
	Connection for heating	Connection for nitrogen	Connection for vapor return line	Unloading connection	Additional personal protection	Delivery temperature
Hexahydro-PSA	½“ Hansen-coupling „male“ (B4KP26)	¾“ Jaw coupling	./.	TW coupling 3“ „female“	Protective suit and full face mask	>50°C
DMT	½“ Hansen-coupling „male“ (B4KP26)	./.	Camlock coupling 1 ½“ „male“ rear/bottom	Camlock coupling 3“ „male“	./.	>150°C
Hexanediol 1.6	½“ Hansen-coupling „male“ (B4KP26)	./.	TW coupling 2“ front/top	„ TW coupling 3“ „female“	./.	>60°C
DADM	Power Connection	./.	¾“ Jaw coupling + Silica gel cartridge with ¾“ Jaw coupling (bottom)	3“-connection with DN100 flange	Protective suit and full face mask	>110°C
Neopentylglykol	½“ Hansen-coupling „male“ (B4KP26)	./.	TW coupling 2“ front/top „male“	TW coupling 3“ „female“	./.	>140°C
MDI	Truck with own heating	Truck with own N2 supply	./.	Rising pipe with 2“-flange	Full face mask	42-46°C
Phenol	½“ Hansen-coupling „male“ (B4KP26)“	./.	TW coupling 2“ top or bottom	TW coupling 3“ „female“	Protective suit and full face mask	>55°C
IPDI (no melt)	./.	¾“ Jaw coupling Top, beside rising pipe	./.	Rising pipe with flange	./.	./.

Building 208 (Isocyanates)

General requirements for all trucks	<ul style="list-style-type: none"> - Deliveries: 6:00 am - 2:00 pm - If possible, only one product per chamber - For trucks: Handrail and continuously walkable area to all connections / hatches - Grounding Connection - Unloading connection: „German“ TW coupling 3“ right side or back side - Vapor return connection: „German“ TW coupling 2“(if necessary, an adapter should be on the truck) - One chamber with unloading connection at the back (centre position) - Sample with delivery / Sample send upfront + COA (Certificate of analysis) - If a vapor return line is necessary, no flame arrester shall be installed! - Delivery temperature 30 - 40°C: Always clarify with Axalta Supply Chain before first delivery!
--	---

Building 214a (Resins)

General requirements for all trucks	<ul style="list-style-type: none"> - Delivery Time: Must be clarified before delivery! - Sample with delivery / Sample send upfront + COA (Certificate of analysis) - If possible, only one product per chamber - For trucks: Handrail and continuously walkable area to all connections / hatches - Grounding connection - One chamber with unloading connection at the back (centre position) - Unloading connection: „German“ TW coupling 3 right side or back side - Vapor return connection: „German“ TW coupling 2 - If a vapor return line is necessary, no flame arrester shall be installed! - Delivery Temperature: Always clarify with Axalta Supply Chain before first delivery!
--	--

Building 218a (Resins)

General requirements for all trucks	<ul style="list-style-type: none">- Delivery: 6:00 am - 5:00 pm- Sample with delivery / Sample send upfront + COA (Certificate of analysis)- If possible, only one product per chamber- For trucks: Handrail and continuously walkable area to all connections / hatches- Grounding connection- One chamber with unloading connection at the back (centre position)- Unloading connection: „German“ TW coupling 3 right side or back side- Vapor return connection: „German“ TW coupling 2- If a vapor return line is necessary, no flame arrester shall be installed!- Delivery Temperature: Always clarify with Axalta Supply Chain before first delivery!
--	---

Building 219 (Resins)

General requirements for all trucks	<ul style="list-style-type: none">- Delivery Time: Must be clarified before delivery!- Sample with delivery / Sample send upfront + COA (Certificate of analysis)- If possible, only one product per chamber- For trucks: Handrail and continuously walkable area to all connections / hatches- Grounding connection- One chamber with unloading connection at the back (centre position)- Unloading connection: „German“ TW coupling 3 right side or back side- Vapor return connection: „German“ TW coupling 2- If a vapor return line is necessary, no flame arrester shall be installed!- Delivery Temperature: Always clarify with Axalta Supply Chain before first delivery!
--	---

Building 220 (Resins)

General requirements for all trucks	<ul style="list-style-type: none">- Delivery: 6:00 am - 2:00 pm- If possible, only one product per chamber- For trucks: Handrail and continuously walkable area to all connections / hatches- Grounding connection- One chamber with unloading connection at the back (centre position)- Unloading connection: „German“ TW coupling 3 “male” right side or back side- Vapor return connection: „German“ TW coupling 3 “female”- Sample with delivery / Sample send upfront + COA (Certificate of analysis)- If a vapor return line is necessary, no flame arrester shall be installed!- Delivery temperature 30 - 40°C: Always clarify with Axalta Supply Chain before first delivery!
--	---

Building 256/258 (Resins)

General requirements for all trucks	<ul style="list-style-type: none"> - Delivery: 6:00 am - 2:00 pm - Sample with delivery / Sample send upfront + COA (Certificate of analysis) - If possible, only one product per chamber - For trucks: Handrail and continuously walkable area to all connections / hatches - Grounding connection - One chamber with unloading connection at the back (centre position) - Unloading connection: „German“ TW coupling 3 Back or rear right/left - Vapor return connection: „German“ TW coupling 2 - If a vapor return line is necessary, no flame arrester shall be installed! - Delivery Temperature: Always clarify with Axalta Supply Chain before first delivery!
--	--

Requirements for Truck Drivers of bulk tank trucks and tanktainers:

Basic knowledge of German facilitates co-operation!
 Samples are generally taken from the bottom (Exception: Tank farm).
 A safety harness shall be use for work on top of the truck.
 Safety clothing must be used for any type of work.

Personal Protection Equipment

Safety clothing:

The use of fire-retardant safety clothing according EN531 is mandatory at the Wuppertal site.
 A chemical protective suit must be used in case the MSDS requires to do so.

Safety glasses / goggles:

Safety glasses with side protection or safety goggles. In addition, a visor shall be used during coupling and de-coupling operation.
 Normal optical glasses do not replace safety glasses!

Safety gloves:

Rubber, nitrile or other solvent resistant materials.
 Leather gloves are permeable for most liquid and therefore not suitable.

Safety shoes:

Safety shoes with steel toe cap, anti-static protection.
 Safety boots must be used in case the MSDS requires to do so.

Safety helmet:

Approved safety helmet, preferably with visor.

10.12 Appendix 12: Requirements for packaging (Montbrison)



For safety reasons, the raw material warehouse introduction should meet the following requirements:

-bags / drum:

- weight=< 25kg

-pallet:

- always in wood
- size 1200x1000mm

-big bag dimensions:

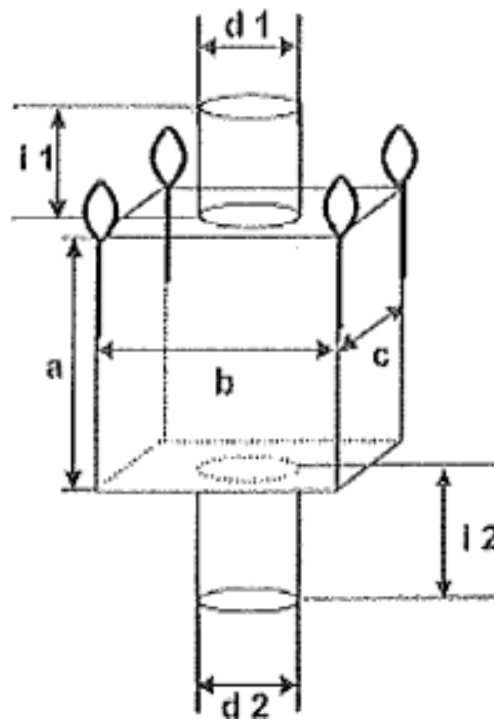

DIMENSIONS:

- a	body height	= 1400 mm tolerance	= + or – 20 mm
- b	body width	= 870 mm	= + or – 10 mm
- c	body length	= 1060 mm	= + or – 10 mm
- i1	filling spout length	= 400 mm = + 50 – 0 mm	
- d1	filling spout diameter	= 420 mm = + or – 10 mm	
- i2	discharge spout length	= 420 mm = + 50 – 0 mm	
- d2	discharge spout diameter	= 420 mm = + or – 10 mm	
-	Loops length	= 250 mm	= + or – 10 mm
-	Weight	= 3.5 kg	
-	Volume / big bag	= 1500 litres	



AXALTA RECONDITIONED DRUMS POLICY

Generally, Axalta accepts only the delivery of products in new steel drums. Under certain circumstances a deviation from this requirement is possible. If supplier wants to, or must, use reconditioned drums for the delivery of products, they must first advise Axalta in writing; and the following minimum requirements must be accepted and fulfilled.

- For the usage of reconditioned drums please contact in advance the responsible Axalta procurement category manager for approval.
- Drums must be free of lint, dirt, oil, rust, silicone or other foreign matter.
- For recondition chemical cleaners must be used. No solid cleaners or burning process is allowed.
- Drums must be free of any remaining washing auxiliaries.
- The following product categories have been judged as non-washable, irrespective of the cleaning process, and are forbidden as pre-drummed material.
 - Adhesives
 - Bitumen
 - Coloured Products
 - Fluorocarbons or fluorine-based products
 - Grease, Lube Oils, Engine Oils
 - Highly toxic Biocides
 - Liquid Chalk and Slurries
 - Mercaptans
 - Molasses
 - Paraffine, waxes with high melting point
 - Peroxides
 - Pump and Hydraulic Oils, Brake Fluids
 - Release agents / flow agents / mould and drawing oils.
 - Silicone compounds
 - Substances with intensive Odours
 - Surfactants
 - Used cooking oils and waste.
- New silicone free seals and closures must be used

Additional or more specific requirements and instructions are given in our supplier directives/requirements and cargo restrictions available at

https://www.axalta.com/corporate/en_US/sustainability/working-with-suppliers.html

Supplier warrants to comply with the minimum requirements for the usage of reconditioned drums mentioned herein and the documents referring to.

Notwithstanding any agreements as to limitations on liability, Supplier shall be liable for all damages/defects where a root cause analysis shows that supplier's actions or inactions to comply with the requirements mentioned herein were the reason for such damage/defect and supplier acted with fault. Notwithstanding anything agreed between supplier and Axalta, supplier will indemnify Axalta for any and all third-party claims for damages/defects to the extent a root cause analysis shows that the respective products delivered in reconditioned drums caused such damages/defects.

Accepted and signed by authorized representative of supplier:

Signature

Name

Title

Date

10.14 Static Dissipative Bags for powder sites

For the use of anti-static bags in the powder stores and in production, consult the table below:

Static dissipative packaging material required?	Warehouse (storing, in-/out bounding)		Operations (weighing/ dispensing, discharging, filling)	
	small bags (<= 25kg filling qty)	Big Bag FIBIC type	small bags (<= 25kg filling qty)	Big Bag FIBIC type
Ordinary Powder finished products (packed into box)	no	B/C/D	no	B/C/D
Powder finished products <10% Alu	no	B/C/D	No - But Best Practice	B/C/D
Powder finished products >10% Alu*)	n.a.	n.a.	n.a.	n.a.
Raw Materials without aluminium	no	B/C/D	no	B/C/D
Aluminium Raw Material	Conductive Container	n.a.	yes	n.a.

*) no metallic products that contain Aluminium pigments in an amount of 10% by weight or more, possible changes in the future to consider